

MP 3068 HT 3~ 210

Technische specificaties

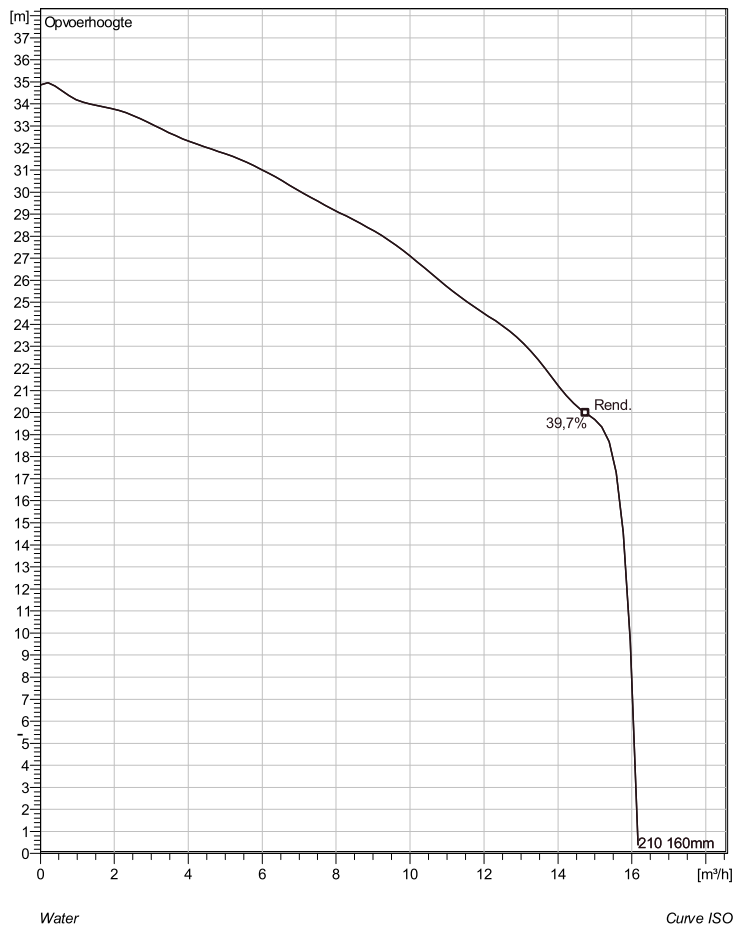

Note: Picture might not correspond to the current configuration.

General

Dompelbare versnijdende pompen specifiek ontwikkeld voor drukriolerings toepassingen. Door de versnijdende werking en hoge druk die de pomp levert, geschikt voor lange leidingtracés.

Impeller

Impeller material	Grey cast iron
Persaansluiting	40 mm
Inlet diameter	40 mm
Impeller diameter	160 mm
Number of blades	10
	6 mm

Motor

Motor #	M3068.170 13-10-2BB-W 2.4KW
Approval	standaard
Stator variant	5
Frequentie	50 Hz
Nominale spanning	400 V
Aantal polen	2
Fasen	3~
Nominaal vermogen	2,4 kW
Toegekende stroom	5,1 A
Aanloopstroom	27 A
Nominaal toerental	2775 rpm
Vermogensfactor	
1/1 Load	0,86
3/4 Load	0,80
1/2 Load	0,68
Motor efficiency	
1/1 Load	79,8 %
3/4 Load	82,7 %
1/2 Load	83,6 %

Installation: P - Semi Permanent, Nat

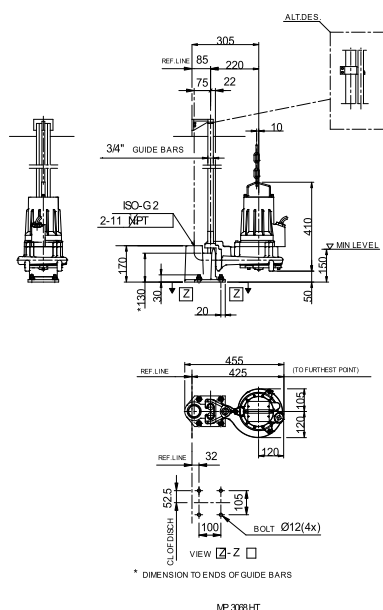

Configuration



T 0294-457712 F 0294-457713 Info@Pompdirect.nl

Project omschrijving	Projectnummer	Aangemaakt door:	Aangemaakt op 10.10.2016	Laatste wijziging
----------------------	---------------	------------------	-----------------------------	-------------------

MP 3068 HT 3~ 210

Karakteristiek

Pomp

Persaansluiting	40 mm
Inlet diameter	40 mm
Impeller diameter	160 mm
Number of blades	10
6 mm	6 mm

Motor

Motor #	M3068.170 13-10-2BB-W 2.4KW
Approval	standaard
Stator variant	5
Frequentie	50 Hz
Nominale spanning	400 V
Aantal polen	2
Fasen	3~
Nominaal vermogen	2,4 kW
Toegekende stroom	5,1 A
Aanloopstroom	27 A
Nominaal toerental	2775 rpm

Vermogensfactor	
1/1 Load	0,86
3/4 Load	0,80
1/2 Load	0,68
Motor efficiency	
1/1 Load	79,8 %
3/4 Load	82,7 %
1/2 Load	83,6 %

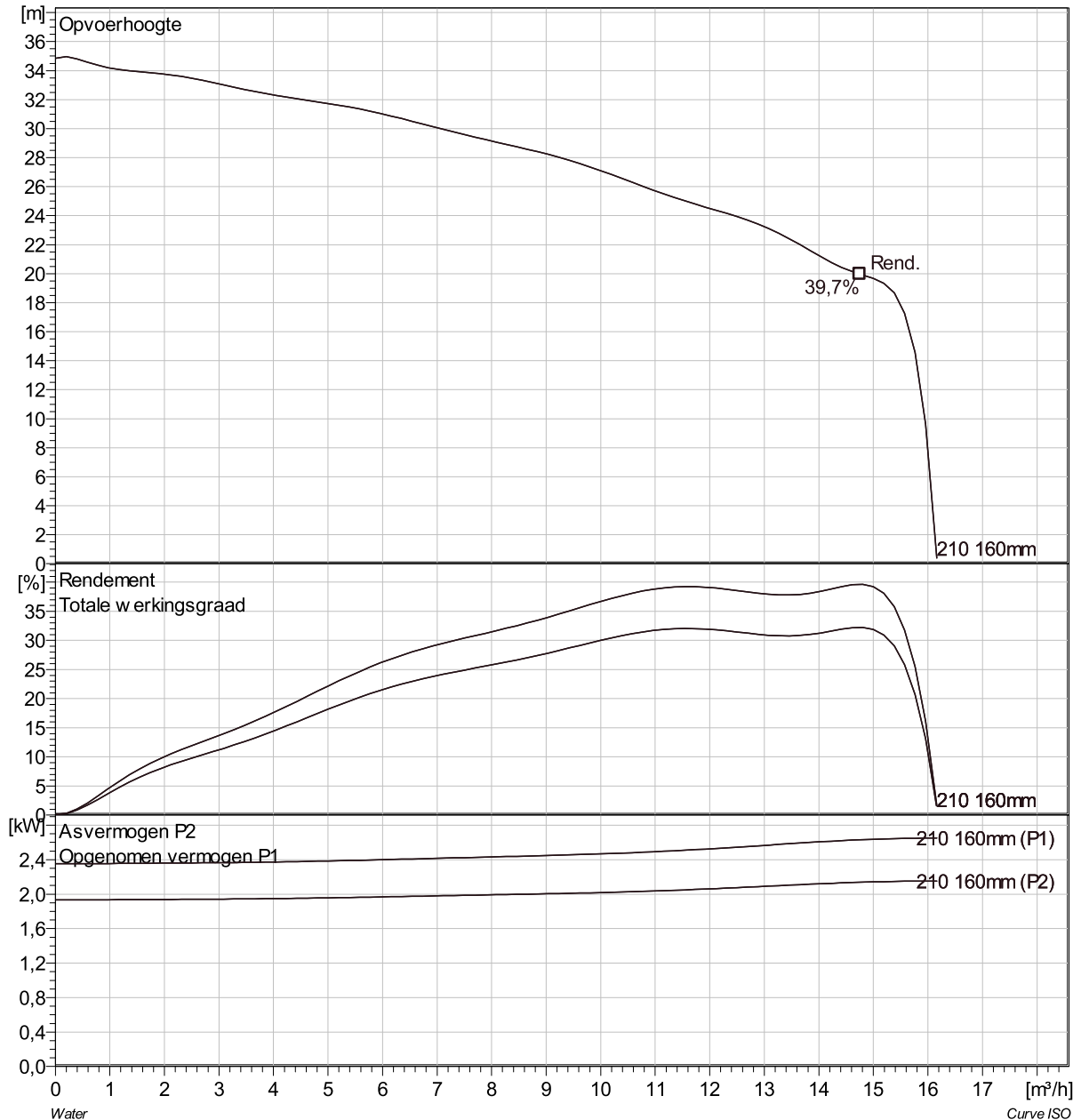

Project omschrijving	Projectnummer	Aangemaakt door:	Aangemaakt op 10.10.2016	Laatste wijziging
----------------------	---------------	------------------	-----------------------------	-------------------

MP 3068 HT 3~ 210 Dimensional drawing

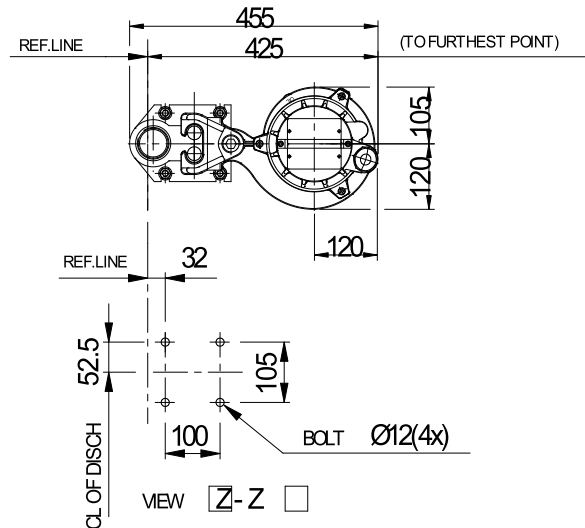
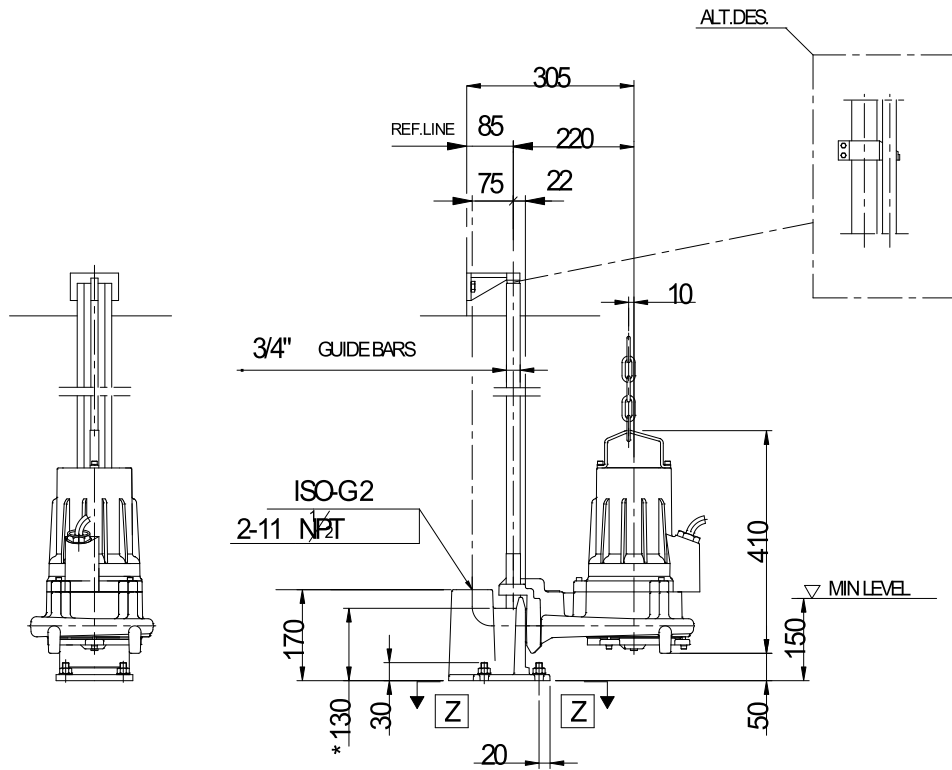

* DIMENSION TO ENDS OF GUIDE BARS

MP3068HT

Project omschrijving	Projectnummer	Aangemaakt door:	Aangemaakt op 10.10.2016	Laatste wijziging
----------------------	---------------	------------------	-----------------------------	-------------------